

## ALKAPO:

Unterkonstruktionen für Aluminium-Profiltafeln und ebene Fassadenplatten (geschosshoch spannbar)

# 04

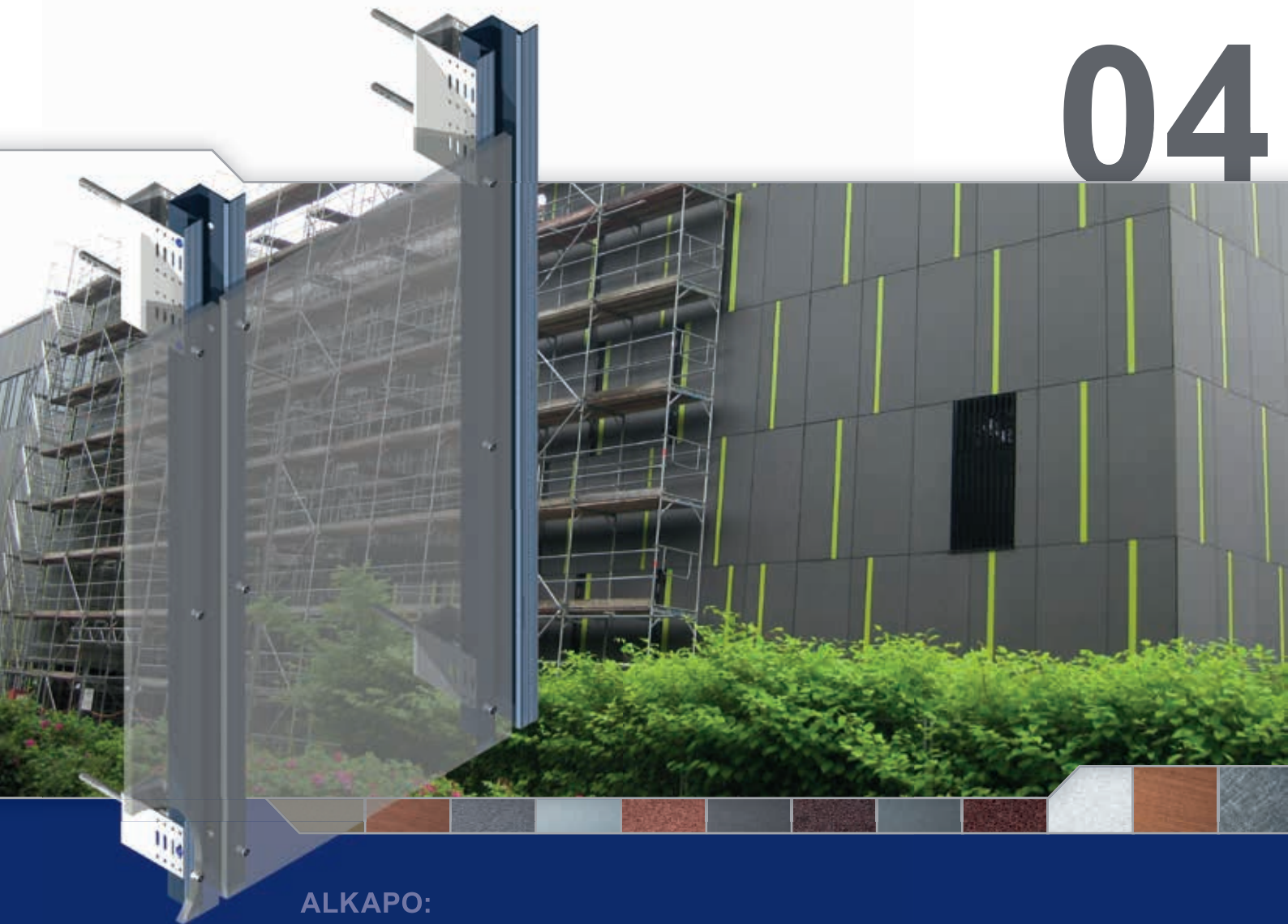

## ALKAPO:

holding tracks for profiled aluminium sheets and flat wall panels (up to floor height)

## ALKAPO:

ossature pour des plaques alu et composants de grandes dimensions

## ALKAPO:

Unterkonstruktionen für Aluminium-Profiltafeln und ebene Fassadenplatten (geschosshoch spannbar)

## ALKAPO:

holding tracks for profiled aluminium sheets and flat wall panels (up to floor height)

## ALKAPO:

ossature pour des plaques alu et composants de grandes dimensions

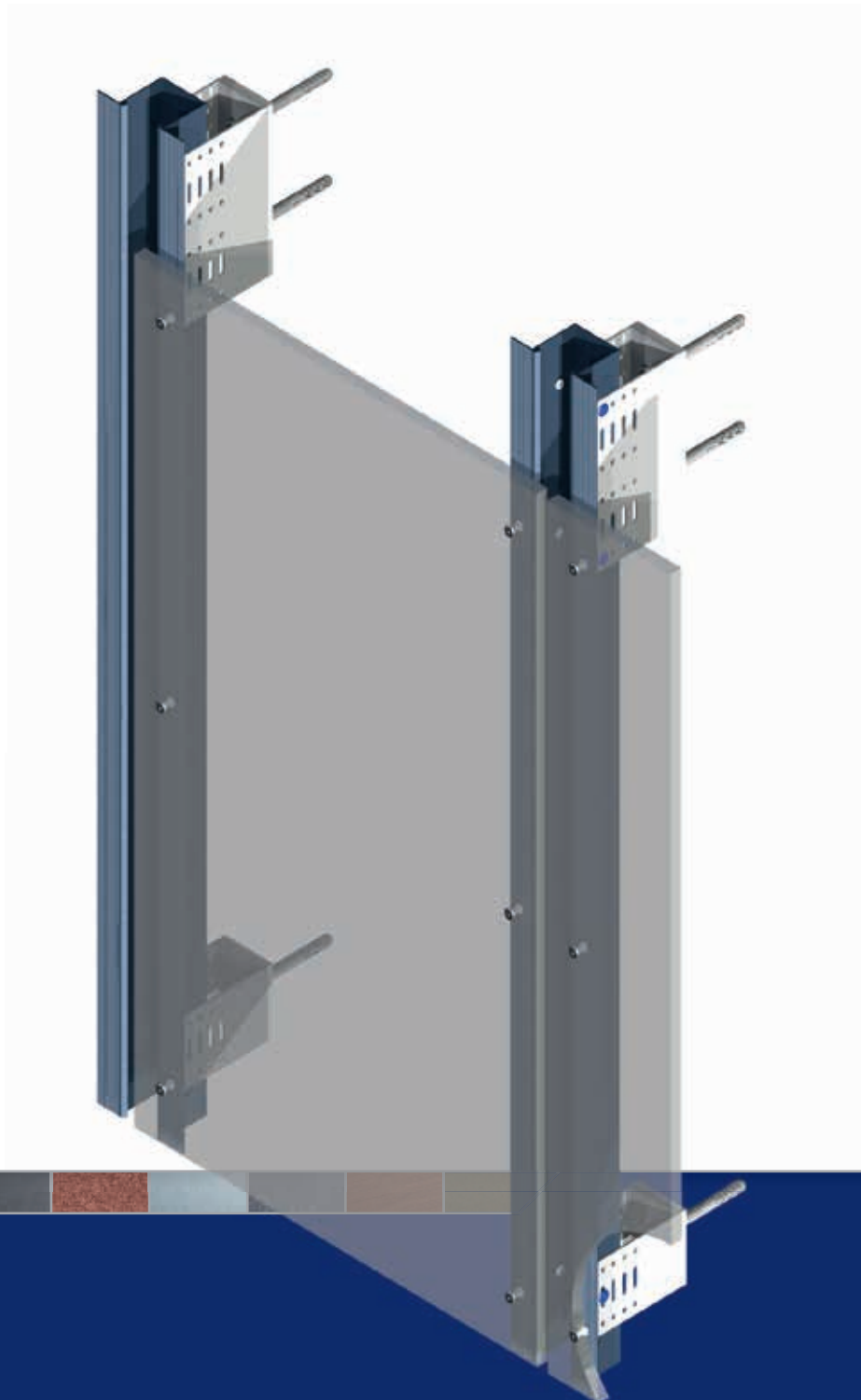

System: **ALKAPO**  
Unterkonstruktionen für Aluminium-Profiltafeln und ebene Fassadenplatten  
(geschosshoch spannbar)

System: **ALKAPO**  
holding tracks for profiled aluminium sheets and flat wall panels (up to floor height)

Système: **ALKAPO**  
ossature pour des plaques alu et composants de grandes dimensions

Seite page page	Schnittübersicht	summary of sections	vue d'ensemble
04.02	Isometrie	isometric view	dessin isométrique
04.03	Schnitt horizontal ALKAPO 275	section horizontal ALKAPO 275	coupe horizontale ALKAPO 275
04.04	Schnitt horizontal ALKAPO 350	section horizontal ALKAPO 350	coupe horizontale ALKAPO 350
04.05	Schnitt vertikal	section vertical	coupe verticale
04.06	Innenecke	internal corner	coin intérieur
04.07	Außenecke	external corner	coin extérieur
04.08	Fenstersturz	window lintel	linteau
04.09	Jalousienkasten	shutter case	carter persienne
04.10	Fensterlaibung	window recess	joue de fenêtre
04.11	Fensterbank	window sill	bavette de fenêtre extérieure
04.12	Sockelabschluss	bottom closure	tôle basse de calfeutrement (raccord de socle)
04.13	Attikaabschluss	parapet	couvre-mur
04.14	Profiliübersicht	profile list ALKAPO	ensemble de profil ALKAPO

## ALKAPO

Schnittübersicht

summary of sections

vue d'ensemble

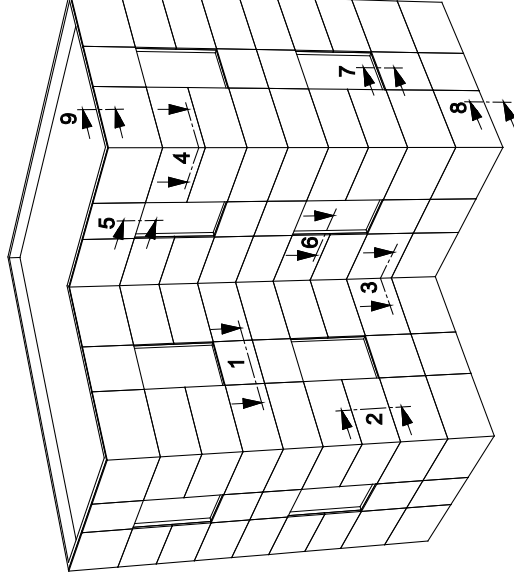

Schnitt 1: horizontal	section 1: horizontal	coupe 1: horizontale
Schnitt 2: vertikal	section 2: vertical	coupe 2: verticale
Schnitt 3: Innenecke	section 3: inner corner	coupe 3: coin intérieur
Schnitt 4: Außenecke	section 4: outer corner	coupe 4: coin extérieur
Schnitt 5: Fenstersturz	section 5: window lintel	coupe 5: linteau
Schnitt 6: Fensterlaibung	section 6: window recess	coupe 6: joue de fenêtre
Schnitt 7: Fensterbank	section 7: windowsill	coupe 7: bavette de fenêtre extérieure
Schnitt 8: Sockelabschluss	section 8: bottom closure	coupe 8: tôle basse de calfeutrement (raccord de socle)
Schnitt 9: Attikaabschluss	section 9: parapet	coupe 9: couvre-mur

## ALKAPO

Unterkonstruktionen  
für Aluminium-  
Profiltafeln und ebene  
Fassadenplatten

holding tracks for  
profiled aluminium  
sheets and flat wall  
panels

ossature pour des plaques  
en alu et composants

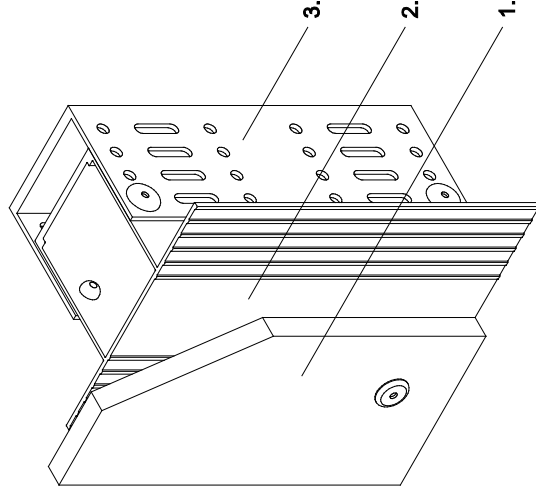

1. Fassadenbekleidung  
ALKAPO
2. senkrechtcs Tragprofil  
ALKAPO
3. Systea U-Wandkonsole

1. cladding panel  
ALKAPO
2. vertical holding track  
ALKAPO
3. Systea U-bracket

1. revêtement de façade  
ALKAPO
2. profil support vertical  
ALKAPO
3. équerre en U Systea

Schnitt 1  
horizontal  
ALKAPO 275

section 1  
horizontal  
ALKAPO 275

coupe 1  
horizontale  
ALKAPO 275

Stoßprofil

butt joint profile

profil d'assemblage

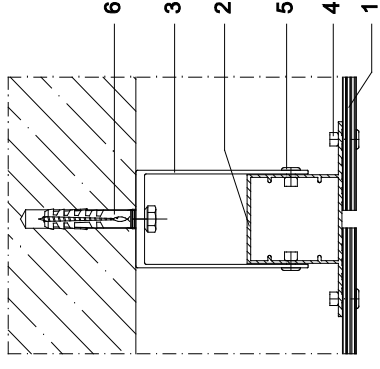

Mittelunterstützung

middle support

support central

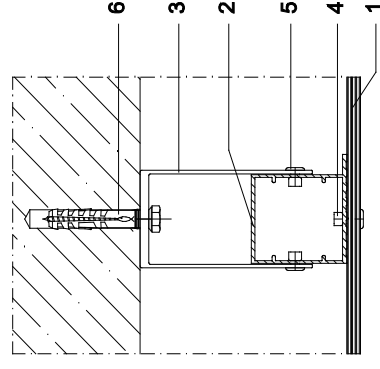

1. Fassadenbekleidung  
senkrechtcs Tragprofil  
ALKAPO 275
2. Systea U-Wandkonsole
3. Befestigungsriev
4. Verbindungsriev
5. Verankerung

1. cladding panel  
vertical holding track  
ALKAPO 275
2. Systea U-bracket
3. fixing rivet
4. connecting rivet
5. fixing

1. revêtement de façade  
profil support vertical  
ALKAPO 275
2. équerre en U Systea
3. rivet de fixation
4. jonction
5. ancrage

**Schnitt 1  
horizontal  
ALKAPO 350**

Stoßprofil

**section 1  
horizontale  
ALKAPO 350**

butt joint profile

**coupe 1  
horizontale  
ALKAPO 350**

profil d'assemblage

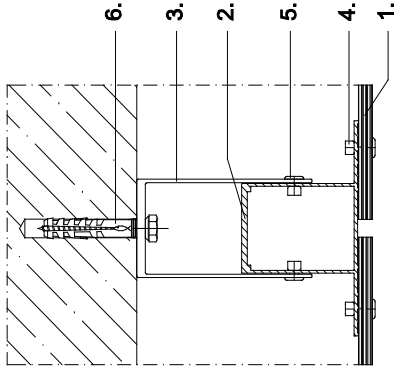

Mittelunterstützung

middle support

support central

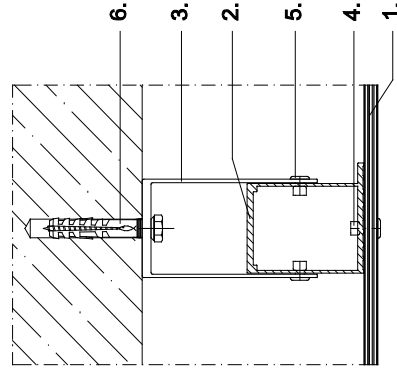

**Schnitt 2  
vertikal**

**section 2  
vertical**

**coupe 2  
verticale**

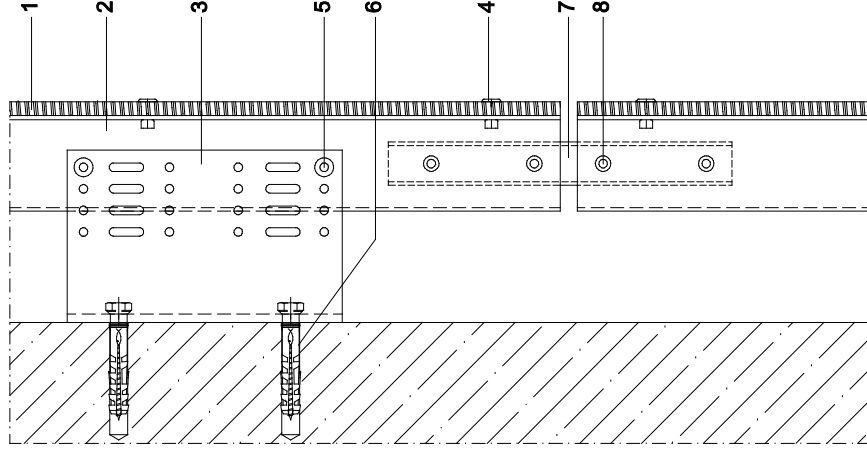

1. Fassadenbekleidung
2. senkrechtcs Tragprofil  
ALKAPO
3. Systea U-Wandkonsole
4. Befestigungsniel
5. Verbindungsniel
6. Verankerung
7. Stoßverbinder
8. Verbindungsniel

1. cladding panel
2. vertical holding track  
ALKAPO
3. Systea U-bracket
4. fixing rivet
5. connecting rivet
6. fixing
7. butt joint
8. connecting rivet

1. revêtement de façade
2. profil support vertical  
ALKAPO
3. équerre en U Systea
4. rivet de fixation
5. jonction
6. ancrage
7. éclisse / raccord
8. jonction

**Schnitt 3**  
Innenecke

**section 3**  
internal corner

**coupe 3**  
coin intérieur

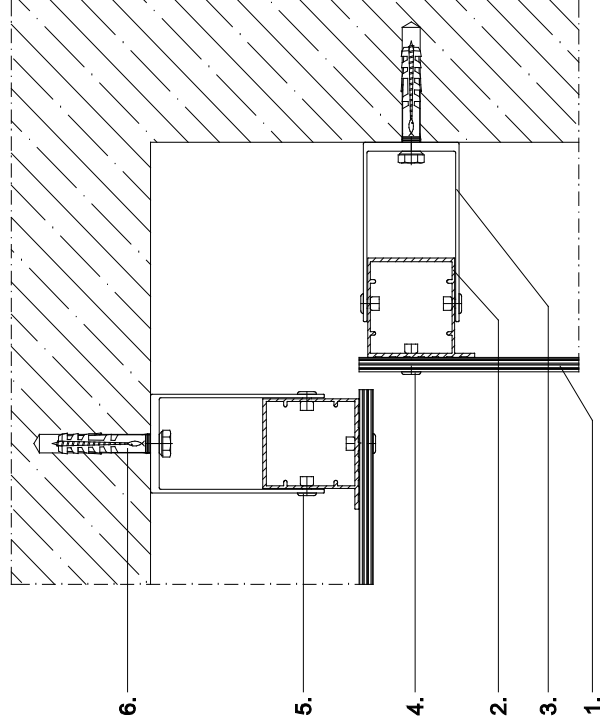

- |                                     |                                      |
|-------------------------------------|--------------------------------------|
| 1. Fassadenbekleidung               | 1. revêtement de façade              |
| 2. senkrechtes Tragprofil<br>ALKAPO | 2. profil support vertical<br>ALKAPO |
| 3. Systea U-Wandkonsole             | 3. équerre en U Systea               |
| 4. Befestigungsniel                 | 4. rivet de fixation                 |
| 5. Verbindungsniel                  | 5. jonction                          |
| 6. Verankerung                      | 6. ancrage                           |

**Schnitt 4**  
Außenecke

**section 4**  
external corner

**coupe 4**  
coin extérieur

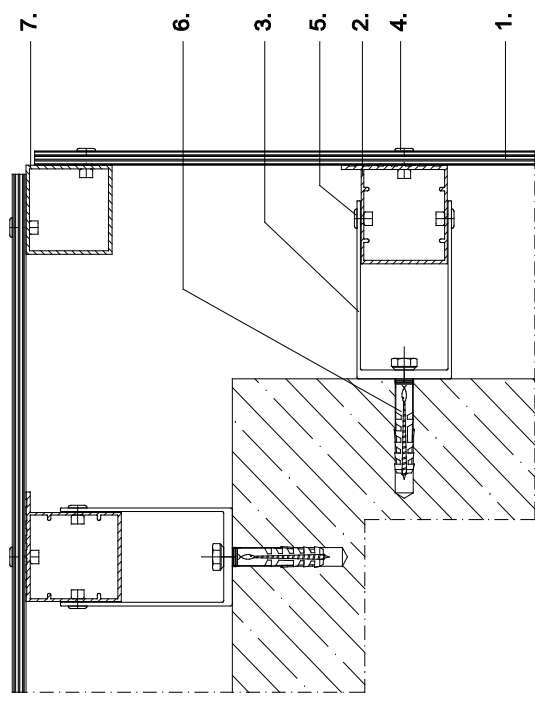

- |                                     |                                       |
|-------------------------------------|---------------------------------------|
| 1. Fassadenbekleidung               | 1. revêtement de façade               |
| 2. senkrechtes Tragprofil<br>ALKAPO | 2. profil support vertical<br>ALKAPO  |
| 3. Systea U-Wandkonsole             | 3. équerre en U Systea                |
| 4. Befestigungsniel                 | 4. rivet de fixation                  |
| 5. Verbindungsniel                  | 5. jonction                           |
| 6. Verankerung                      | 6. ancrage                            |
| 7. Systea Außeneckprofil            | 7. profil de coin extérieur<br>Systea |

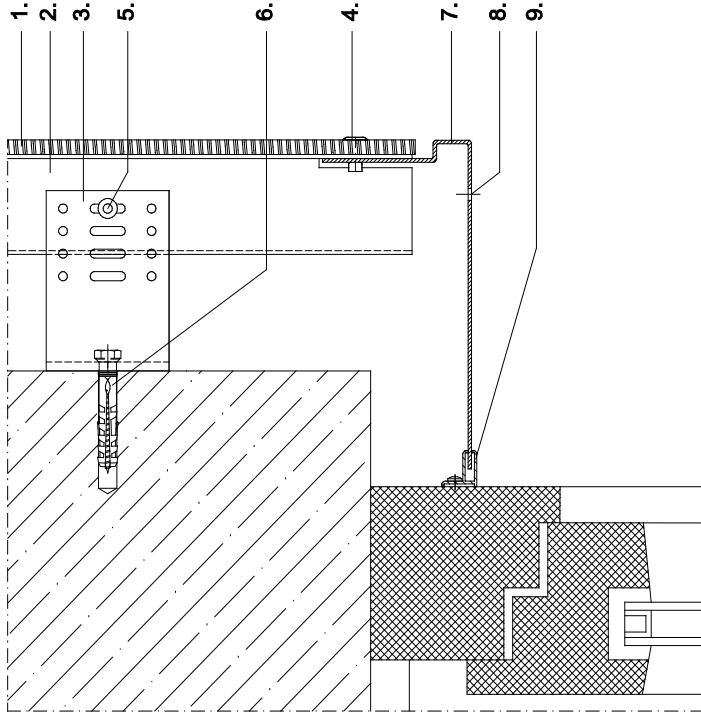

1. Fassadenbekleidung
2. senkrechtcs Tragprofil  
ALKAPO
3. Systea U-Wandkonsole
4. Befestigungsniel
5. Verbindungsniel
6. Verankerung
7. Fensterzarge
8. Belüftungsöffnung
9. Systea Stimmgabelprofil

1. cladding panel
2. vertical holding track  
ALKAPO
3. Systea U-bracket
4. fixing rivet
5. connecting rivet
6. fixing
7. window frame
8. ventilation opening
9. Systea F-profile  
(diapason)

1. revêtement de façade
2. profil support vertical  
ALKAPO
3. étrier en U Systea
4. rivet de fixation
5. jonction
6. ancrage
7. châssis
8. trou pour ventilation
9. profil F Systea  
(diapason)

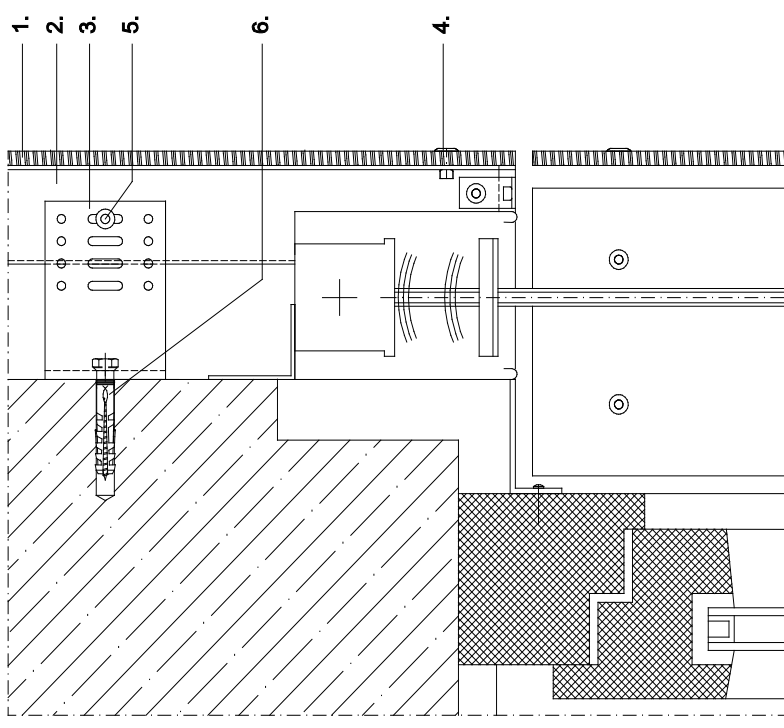

1. Fassadenbekleidung
2. senkrechtcs Tragprofil  
ALKAPO
3. Systea U-Wandkonsole
4. Befestigungsniel
5. Verbindungsniel
6. Verankerung

1. cladding panel
2. vertical holding track  
ALKAPO
3. Systea U-bracket
4. fixing rivet
5. connecting rivet
6. fixing

1. revêtement de façade
2. profil support vertical  
ALKAPO
3. étrier en U Systea
4. rivet de fixation
5. jonction
6. ancrage

**Schnitt 6**  
Fensterlaibung

**section 6**  
window recess

**coupe 6**  
joue de fenêtre

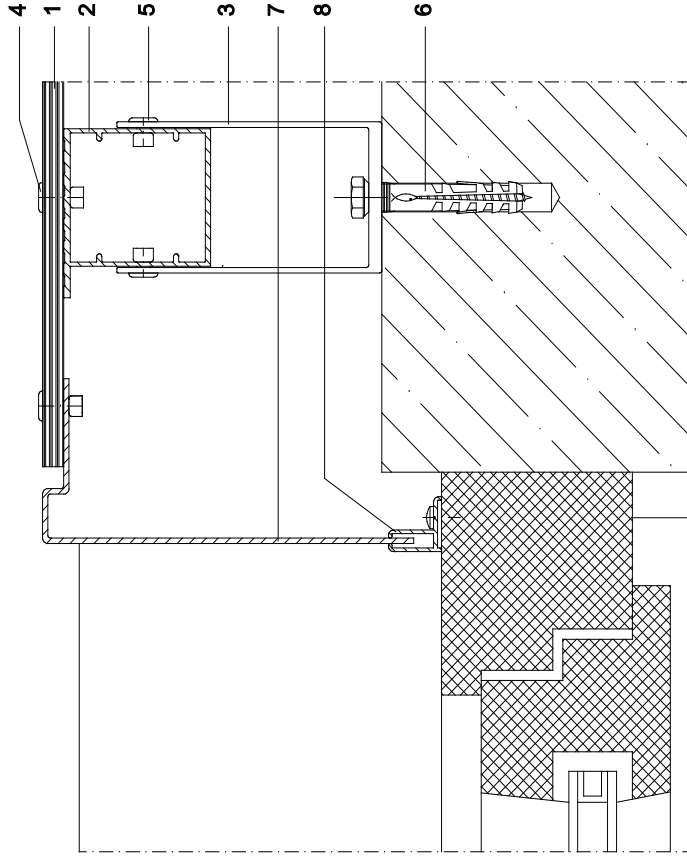

1. Fassadenbekleidung
2. senkrechtcs Tragprofil  
ALKAPO
3. Systea U-Wandkonsole
4. Befestigungsniel
5. Verbindungsniel
6. Verankerung
7. Fensterzarge
8. Systea Stimmgabelprofil

1. cladding panel
2. vertical holding track  
ALKAPO
3. Systea U-bracket
4. fixing rivet
5. connecting rivet
6. fixing
7. window frame
8. Systea F-profile  
(diapason)

1. revêtement de façade
2. profil support vertical  
ALKAPO
3. équerre en U Systea
4. rivet de fixation
5. jonction
6. ancrage
7. châssis
8. profil F Systea  
(diapason)

**Schnitt 7**  
Fensterbank

**section 7**  
windowsill

**coupe 7**  
bavette de fenêtre  
extérieure

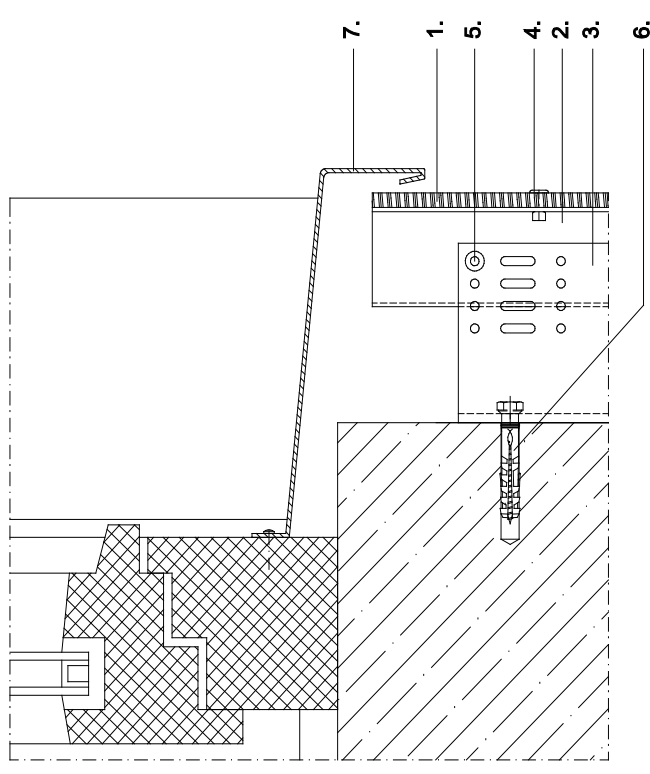

1. Fassadenbekleidung
2. senkrechtcs Tragprofil  
ALKAPO
3. Systea U-Wandkonsole
4. Befestigungsniel
5. Verbindungsniel
6. Verankerung
7. Systea Fensterbank

1. cladding panel
2. vertical holding track  
ALKAPO
3. Systea U-bracket
4. fixing rivet
5. connecting rivet
6. fixing
7. Systea windowsill

1. revêtement de façade
2. profil support vertical  
ALKAPO
3. équerre en U Systea
4. rivet de fixation
5. jonction
6. ancrage
7. bavette Systea



**Schnitt 8**  
Sockelabschluss

**section 8**  
bottom closure

**coupe 8**  
tôle basse de  
caifement  
(raccord de socle)

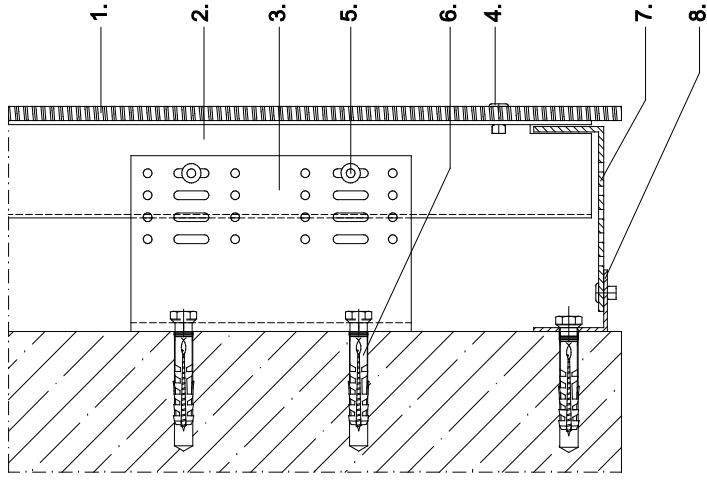

1. Fassadenbekleidung
2. senkrechtes Tragprofil  
ALKAPO
3. Systea U-Wandkonsole
4. Befestigungsniel
5. Verbindungsniel
6. Verankerung
7. Abschlusswinkel mit  
Belüftung
8. Wandwinkel

1. cladding panel
2. vertical holding track  
ALKAPO
3. Systea U-bracket
4. fixing rivet
5. connecting rivet
6. fixing
7. base angle with  
ventilation system
8. wall angle

1. revêtement de façade
2. profil support vertical  
ALKAPO
3. étrier en U Systea
4. rivet de fixation
5. jonction
6. ancrage
7. angle avec trou  
de ventilation
8. angle

**Schnitt 9**  
Attikaabschluss

**section 9**  
parapet

**coupe 9**  
couvre-mur

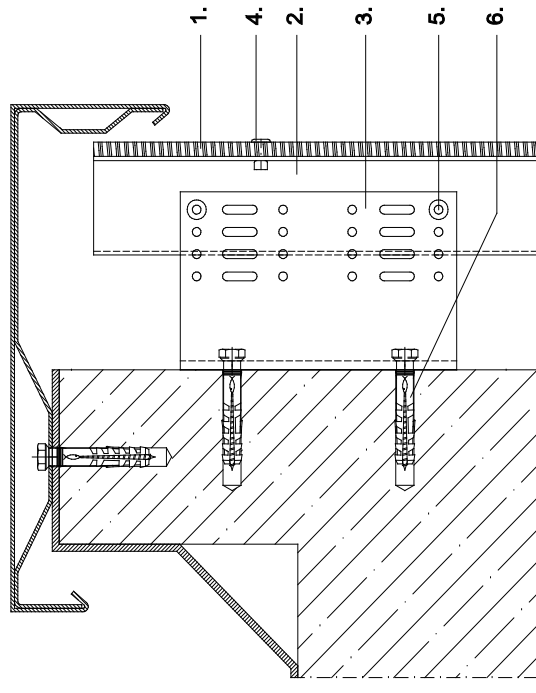

1. Fassadenbekleidung
2. senkrechtes Tragprofil  
ALKAPO
3. Systea U-Wandkonsole
4. Befestigungsniel
5. Verbindungsniel
6. Verankerung

1. cladding panel
2. vertical holding track  
ALKAPO
3. Systea U-bracket
4. fixing rivet
5. connecting rivet
6. fixing

1. revêtement de façade
2. profil support vertical  
ALKAPO
3. étrier en U Systea
4. rivet de fixation
5. jonction
6. ancrage

## Inhaltsverzeichnis Profilübersicht ALKAPO

### Contents profile list ALKAPO

### Index ensemble de profil ALKAPO

Seite page	Profile vertical holding tracks ALKAPO	profiles rails porteurs verticaux ALKAPO
04.16	275-Mittelunterstützung 275-Stoßprofil prof.	275-support central 275-profil pour plaque bout à bout prof.
04.17	350-Mittelunterstützung 350-Stoßprofil, 120er Ansicht prof.	350-support central 350-profil pour plaque bout à bout, vue de 120 prof.
	<b>U-Wandkonsolen</b>	<b>équerres en U</b>
04.18	UH 40/55/40 -70/160mm UH 60/55/60 -70/160mm	UH 40/55/40 -70/160mm UH 60/55/60 -70/160mm
04.19	UH 80/55/80 -70/160mm UH 100/55/100 -70/160mm	UH 80/55/80 -70/160mm UH 100/55/100 -70/160mm
04.20	UH 120/55/120 -70/160mm UH 135/57/135 -70/160mm	UH 120/55/120 -70/160mm UH 135/57/135 -70/160mm
04.21	UH 150/57/150 -70/160mm UH 180/57/180 -70/160mm	UH 150/57/150 -70/160mm UH 180/57/180 -70/160mm

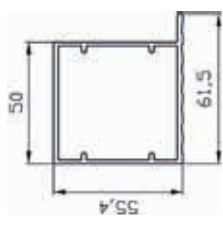
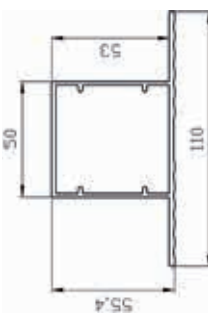
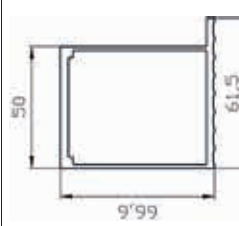
Profiltyp profile type type de profil	Länge (mm) length (mm) longueur (mm)	Material material matériel	Einzelpreis unit price prix unitaire
 <p>ALKAPO 275-Mittelunterstützung 275-middle support 275-support central</p>	5500	EN AW 6063 T66	
	6000		
 <p>ALKAPO 275-Stoßprofil prof. 275-butt joint profile prof. 275-profil pour plaque bout à bout prof.</p>	5500	EN AW 6063 T66	
	6000		
 <p>ALKAPO 350-Mittelunterstützung 350-middle support 350-support central</p>	5500	EN AW 6063 T66	
	6000		

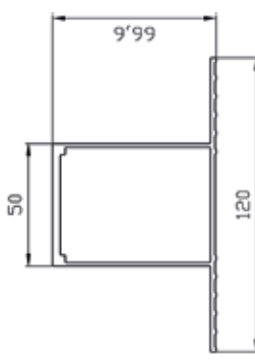
Profiltyp profile type type de profil	Länge (mm) length (mm) longueur (mm)	Material material matériel	Einzelpreis unit price prix unitaire
 <p>ALKAPO 350-Stoßprofil, 120er Ansicht prof. 350-butt joint profile, 120er view prof. 350-profil pour plaque bout à bout, vue de 120 prof.</p>	5500 6000	EN AW 6063 T66	

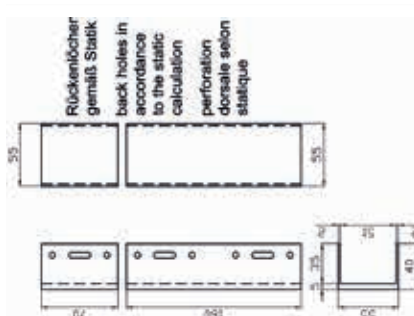
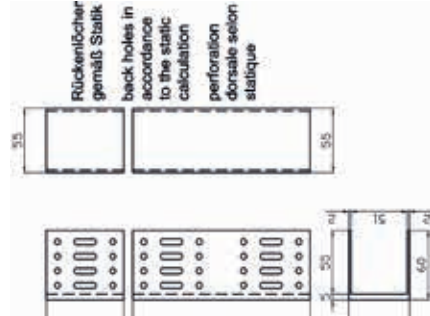
Profiltyp profile type type de profil	Länge (mm) length (mm) longueur (mm)	Material material matériel	Einzelpreis unit price prix unitaire
 <p>UH 40/55/40 - 70/160mm</p> <p>Rückenkücher gemäß Statik back holes in accordance to the static calculation perforation dorsale selon statique</p>	UH 40/55/40-70 UH 40/55/40-160	EN AW 6063 T66 EN AW 6063 T66	
 <p>UH 60/55/60 - 70/160mm</p> <p>Rückenkücher gemäß Statik back holes in accordance to the static calculation perforation dorsale selon statique</p>	UH 60/55/60-70 UH 60/55/60-160	EN AW 6063 T66 EN AW 6063 T66	

Profiltyp profile type type de profil	Länge (mm) length (mm) longueur (mm)	Material material matériel	Einzelpreis unit price prix unitaire
 <p>UH 80/55/80 - 70/160mm</p>	UH 80/55/80 - 70	EN AW 6063 T66	
	UH 80/55/80-160	EN AW 6063 T66	
 <p>UH 100/55/100 - 70/160mm</p>	UH 100/55/100-70	EN AW 6063 T66	
	UH 100/55/100-160	EN AW 6063 T66	

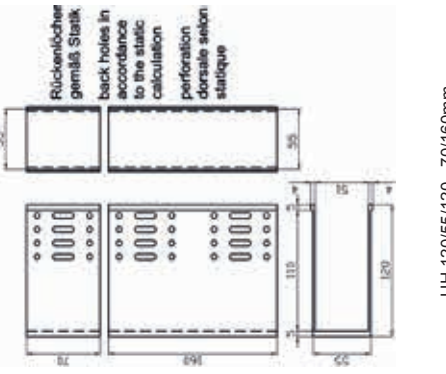
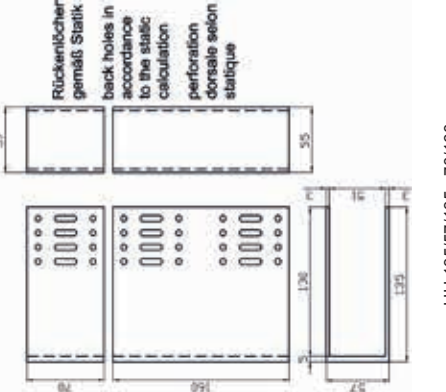
Profiltyp profile type type de profil	Länge (mm) length (mm) longueur (mm)	Material material matériel	Einzelpreis unit price prix unitaire
 <p>UH 120/55/120 - 70/160mm</p>	UH 120/55/120-70	EN AW 6063 T66	
	UH 120/55/120-160	EN AW 6063 T66	
 <p>UH 135/57/135 - 70/160mm</p>	UH 135/57/135-70	EN AW 6063 T66	
	UH 135/57/135-160	EN AW 6063 T66	

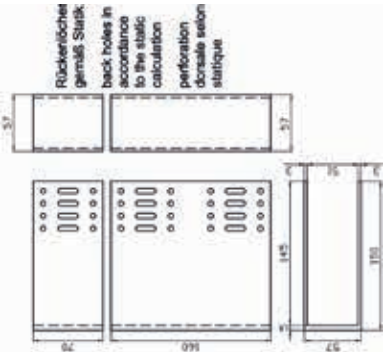
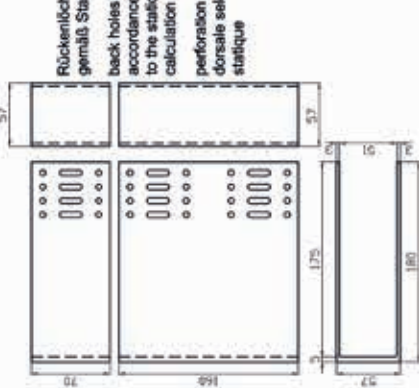
Profiltyp profile type type de profil	Länge (mm) length (mm) longueur (mm)	Material material matériel	Einzelpreis unit price prix unitaire
 <p>Rückenlöcher gemäß Statik back holes in accordance to the static calculation perforation dorsale selon statique</p> <p>UH 150/57/150 - 70/160mm</p>	<p>UH150/57/150-70</p> <p>UH150/57/150-160</p>	<p>EN AW 6063 T66</p> <p>EN AW 6063 T66</p>	
 <p>Rückenlöcher gemäß Statik back holes in accordance to the static calculation perforation dorsale selon statique</p> <p>UH 180/57/180 - 70/160mm</p>	<p>UH180/57/180-70</p> <p>UH180/57/180-160</p>	<p>EN AW 6063 T66</p> <p>EN AW 6063 T66</p>	

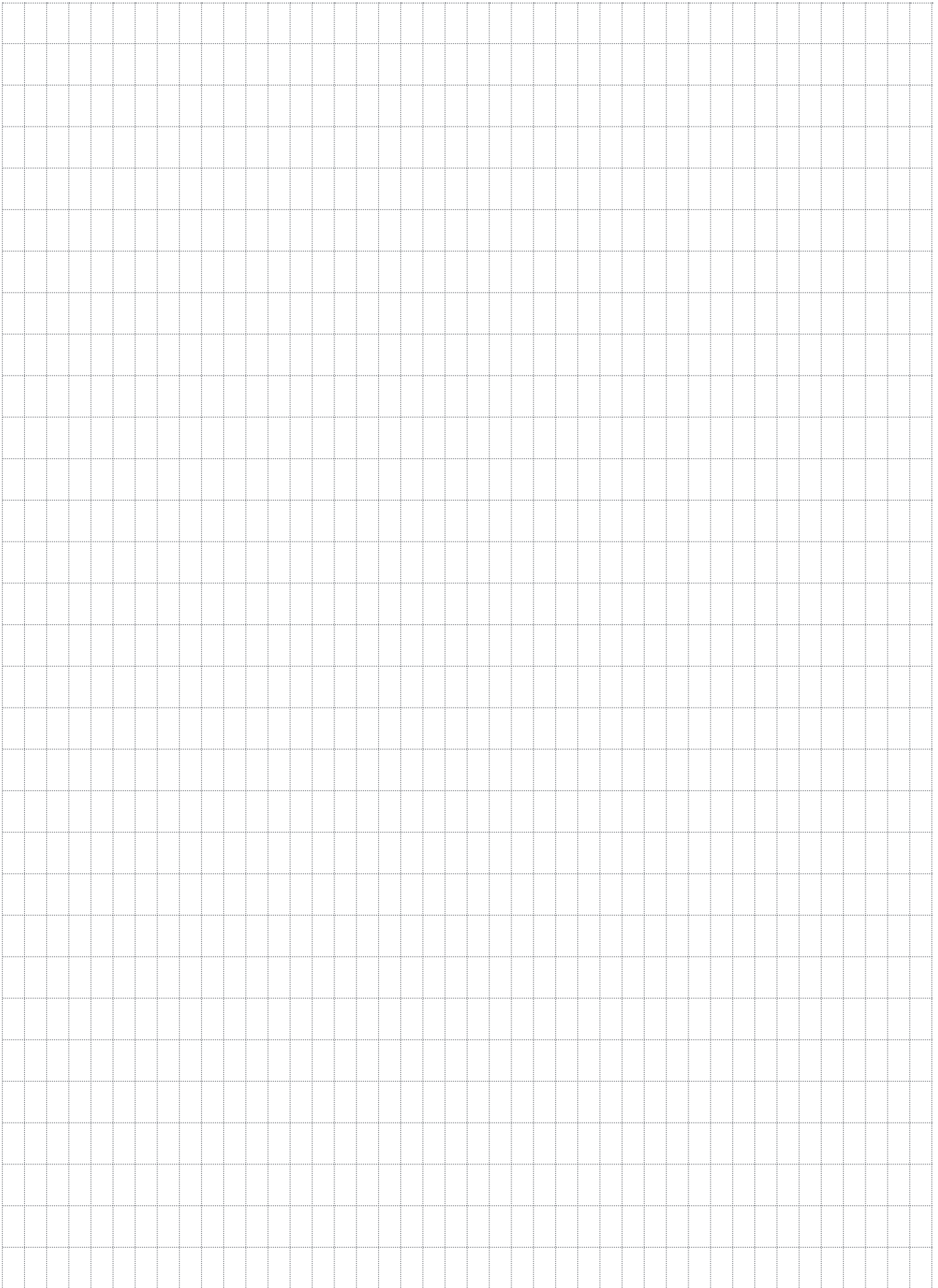



# Systema®

## Systema Pohl GmbH

Margarete-Steiff-Str. 6  
D-24558 Henstedt-Ulzburg  
Deutschland / Germany

Fon: +49 (0) 41 93 / 99 11-0  
Fax: +49 (0) 41 93 / 99 11-49

info@systema.systems  
www.systema.systems



Bitte besuchen Sie uns für weitere  
technische Informationen und  
eine Vielzahl von Referenzen  
im Internet: [www.systema.systems](http://www.systema.systems)

Ein Unternehmen der  
POHL-Gruppe